

Pecco SK 225

TOWER CRANE

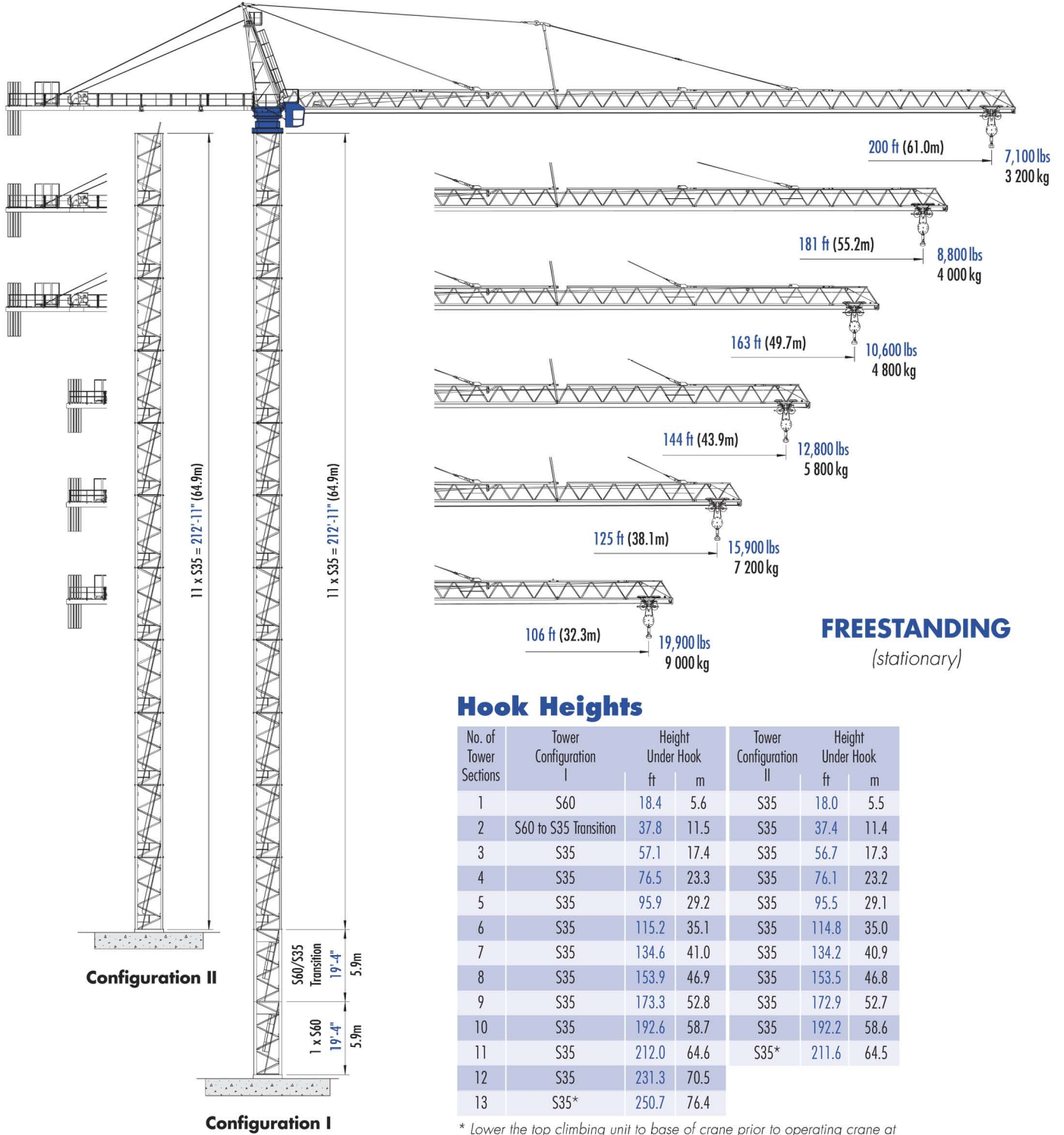

FREESTANDING
(stationary)

Hook Heights

No. of Tower Sections	Tower Configuration I	Height Under Hook		Tower Configuration II	Height Under Hook	
		ft	m		ft	m
1	S60	18.4	5.6	S35	18.0	5.5
2	S60 to S35 Transition	37.8	11.5	S35	37.4	11.4
3	S35	57.1	17.4	S35	56.7	17.3
4	S35	76.5	23.3	S35	76.1	23.2
5	S35	95.9	29.2	S35	95.5	29.1
6	S35	115.2	35.1	S35	114.8	35.0
7	S35	134.6	41.0	S35	134.2	40.9
8	S35	153.9	46.9	S35	153.5	46.8
9	S35	173.3	52.8	S35	172.9	52.7
10	S35	192.6	58.7	S35	192.2	58.6
11	S35	212.0	64.6	S35*	211.6	64.5
12	S35	231.3	70.5			
13	S35*	250.7	76.4			

* Lower the top climbing unit to base of crane prior to operating crane at maximum hook height.

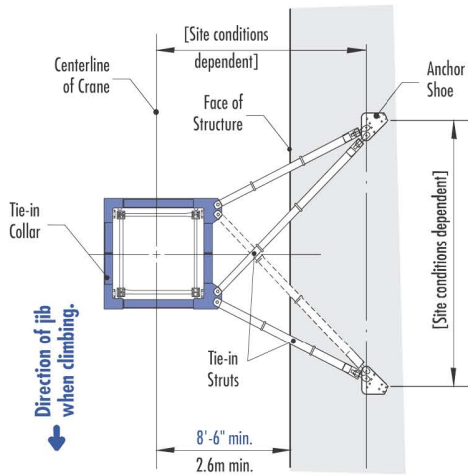

TIE-IN ASSEMBLY
(Plan View)

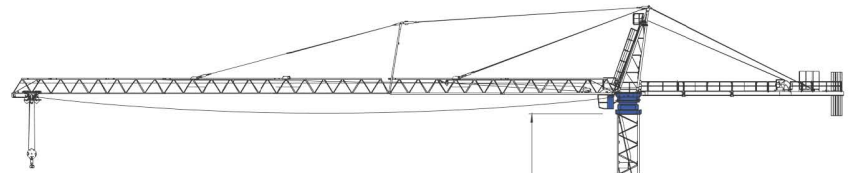

NOTE! If hook height exceeds 330 ft (100m), the number of tower sections above the uppermost tie-in location **MUST** be reduced by 1 tower section.

* Lower the top climbing unit to the uppermost tie-in prior to operating crane at maximum hook height.

IMPORTANT! Please consult crane's operation manual before erecting, operating and dismantling crane.

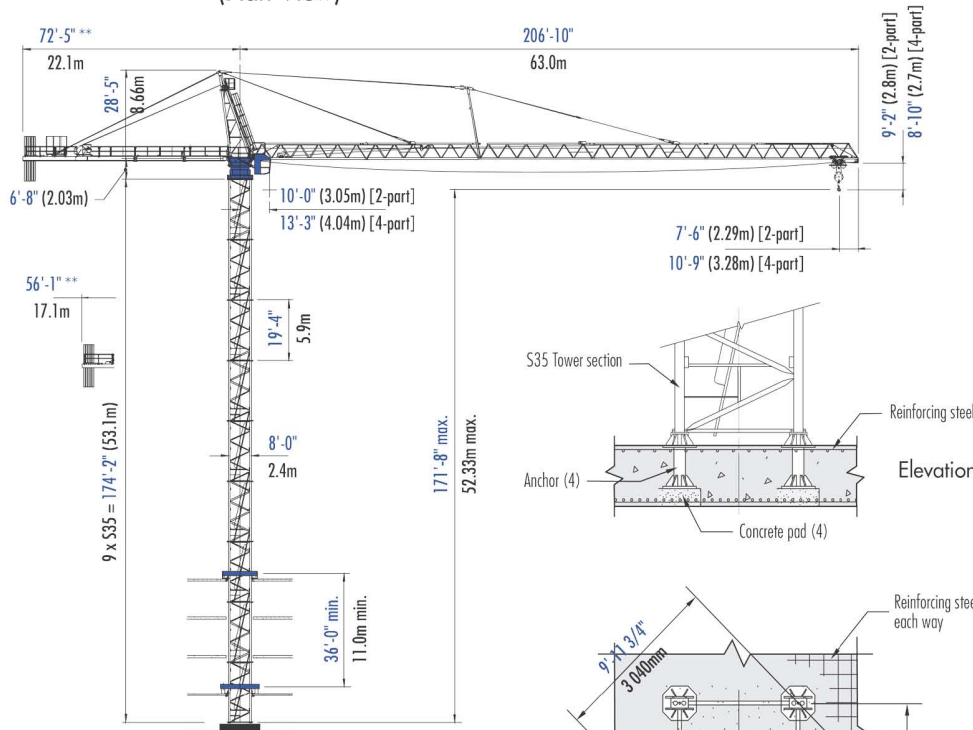

BOTTOM CLIMBING
with S35 Tower Sections
(Inside Structure)

****NOTE!** Jibs with a hook reach of 163 ft (49.7m) and longer require the 72'-5" (22.1m) counterjib; for jibs with a hook reach of 144 ft (43.9m) or shorter, the 56'-1" (17.1m) counterjib is required.

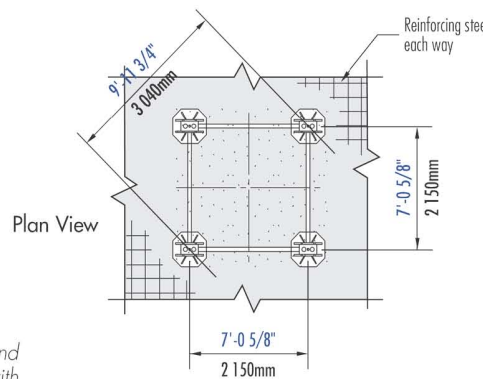

FOUNDATION DETAILS
with S35 Tower Sections
(Concrete Slab)

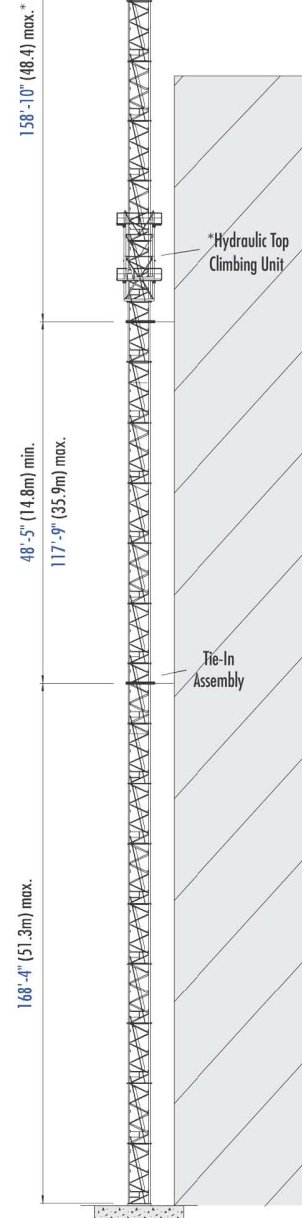

TOP CLIMBING
with S35 Tower Sections
(Tied to Structure)

Radius and Capacities

Pecco Tower Crane Model SK 225

2-Part Line

Hook Radius	2-Part Line Max Capacity — Radius	ft m	80	90	100	106	110	120	125	130	140	144	150	160	163	170	181	190	200	
			24.4	27.4	30.5	32.3	33.5	36.6	38.1	39.6	42.7	43.9	45.7	48.8	49.7	51.8	55.2	57.9	61.0	
200 ft 61.0m	22,050 lbs — 79 ft 10 000 kg — 24.0m	lbs kg	21,760 9 870	18,800 8 530	16,800 7 620	15,700 7 120	15,000 6 800	13,600 6 170	12,900 5 850	12,300 5 580	11,200 5 080	10,800 4 900	10,200 4 630	9,400 4 260	9,200 4 170	8,700 3 950	7,900 3 580	7,400 3 360	7,100 3 200	
181 ft 55.2m	22,050 lbs — 85 ft 10 000 kg — 25.9m	lbs kg	22,050 10 000	20,400 9 250	18,200 8 260	17,100 7 760	16,300 7 390	14,800 6 710	14,200 6 440	13,500 6 120	12,300 5 580	11,900 5 400	11,300 5 130	10,400 4 720	10,200 4 630	9,600 4 350	8,800 4 000			
163 ft 49.7m	22,050 lbs — 88 ft 10 000 kg — 26.8m	lbs kg	22,050 10 000	21,300 9 660	19,100 8 660	17,900 8 120	17,200 7 800	15,400 6 990	14,800 6 710	14,000 6 350	12,800 5 810	12,400 5 620	11,800 5 350	10,800 4 900	10,600 4 800					
144 ft 43.9m	22,050 lbs — 90 ft 10 000 kg — 27.4m	lbs kg	22,050 10 000	22,050 10 000	19,700 8 940	18,500 8 390	17,700 8 030	15,900 7 210	15,300 6 940	14,500 6 580	13,200 5 990	12,800 5 800								
125 ft 38.1m	22,050 lbs — 94 ft 10 000 kg — 28.7m	lbs kg	22,050 10 000	22,050 10 000	20,500 9 300	19,300 8 750	18,400 8 350	16,700 7 580	15,900 7 200											
106 ft 32.3m	22,050 lbs — 96 ft 10 000 kg — 29.3m	lbs kg	22,050 10 000	22,050 10 000	21,200 9 620	19,900 9 000														

Capacity

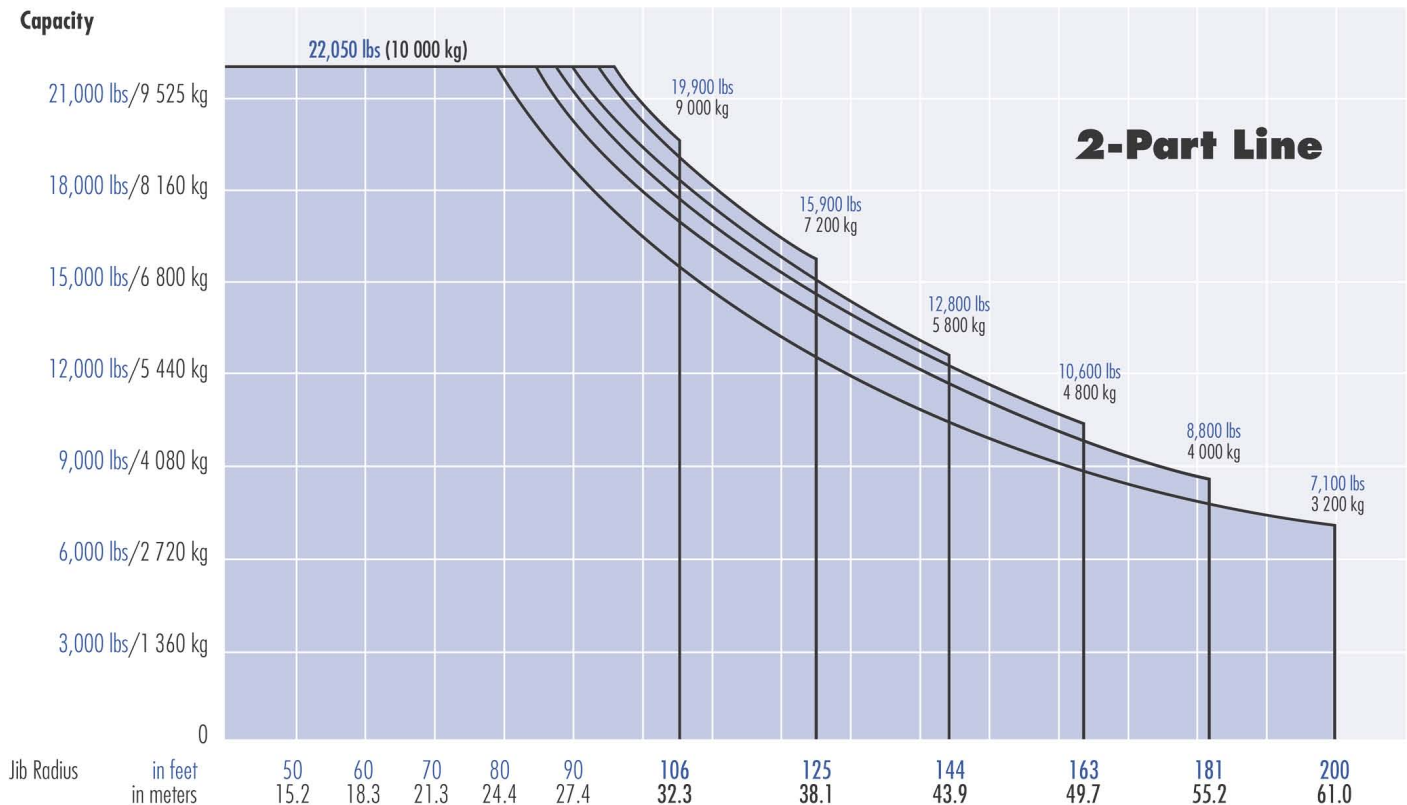

Radius and Capacities

Pecco Tower Crane Model SK 225

4-Part Line

Hook Radius	4-Part Line Max Capacity – Radius	ft m	42	50	60	70	80	90	102	110	121	130	140	150	159	170	178	190	197	
			12.8	15.2	18.3	21.3	24.4	27.4	31.2	33.5	37.0	39.6	42.7	45.7	48.5	51.8	54.2	57.9	60.0	
197 ft 60.0m	44,100 lbs – 42 ft 20 000 kg – 12.8m	lbs kg	44,100 20 000	35,300 16,010	28,400 12 880	23,600 10 700	20,100 9 120	17,300 7 850	14,600 6 620	13,200 5 990	11,600 5 260	10,600 4 810	9,600 4 350	8,600 3 900	7,700 3 490	6,900 3 130	6,400 2 900	5,700 2 590	5,500 2 500	
178 ft 54.2m	44,100 lbs – 45 ft 20 000 kg – 13.7m	lbs kg	44,100 20 000	38,200 17 330	30,800 13 970	25,500 11 570	21,700 9 840	18,800 8 530	15,900 7 210	14,500 6 580	12,800 5 810	11,700 5 310	10,500 4 760	9,500 4 310	8,700 3 950	7,700 3 490	7,200 3 300			
159 ft 48.5m	44,100 lbs – 46 ft 20 000 kg – 14.0m	lbs kg	44,100 20 000	39,800 18 050	32,200 14 610	26,600 12 070	22,700 10 300	19,700 8 940	16,800 7 620	15,300 6 940	13,500 6 120	12,300 5 580	11,000 4 990	9,900 4 490	9,100 4 100					
140 ft 42.7m	44,100 lbs – 47 ft 20 000 kg – 14.3m	lbs kg	44,100 20 000	41,000 18 600	33,100 15 010	27,300 12 380	23,300 10 570	20,300 9 210	17,400 7 890	15,800 7 170	13,900 6 310	12,700 5 760	11,500 5 200							
121 ft 37.0m	44,100 lbs – 49 ft 20 000 kg – 14.9m	lbs kg	44,100 20 000	43,000 19 500	34,800 15 790	28,800 13 060	24,300 11 020	21,300 9 660	18,300 8 300	16,600 7 530	14,700 6 700									
102 ft 31.2m	44,100 lbs – 50 ft 20 000 kg – 15.2m	lbs kg	44,100 20 000	44,100 20 000	35,900 16 280	29,700 13 470	25,200 11 430	21,900 9 930	18,800 8 500											

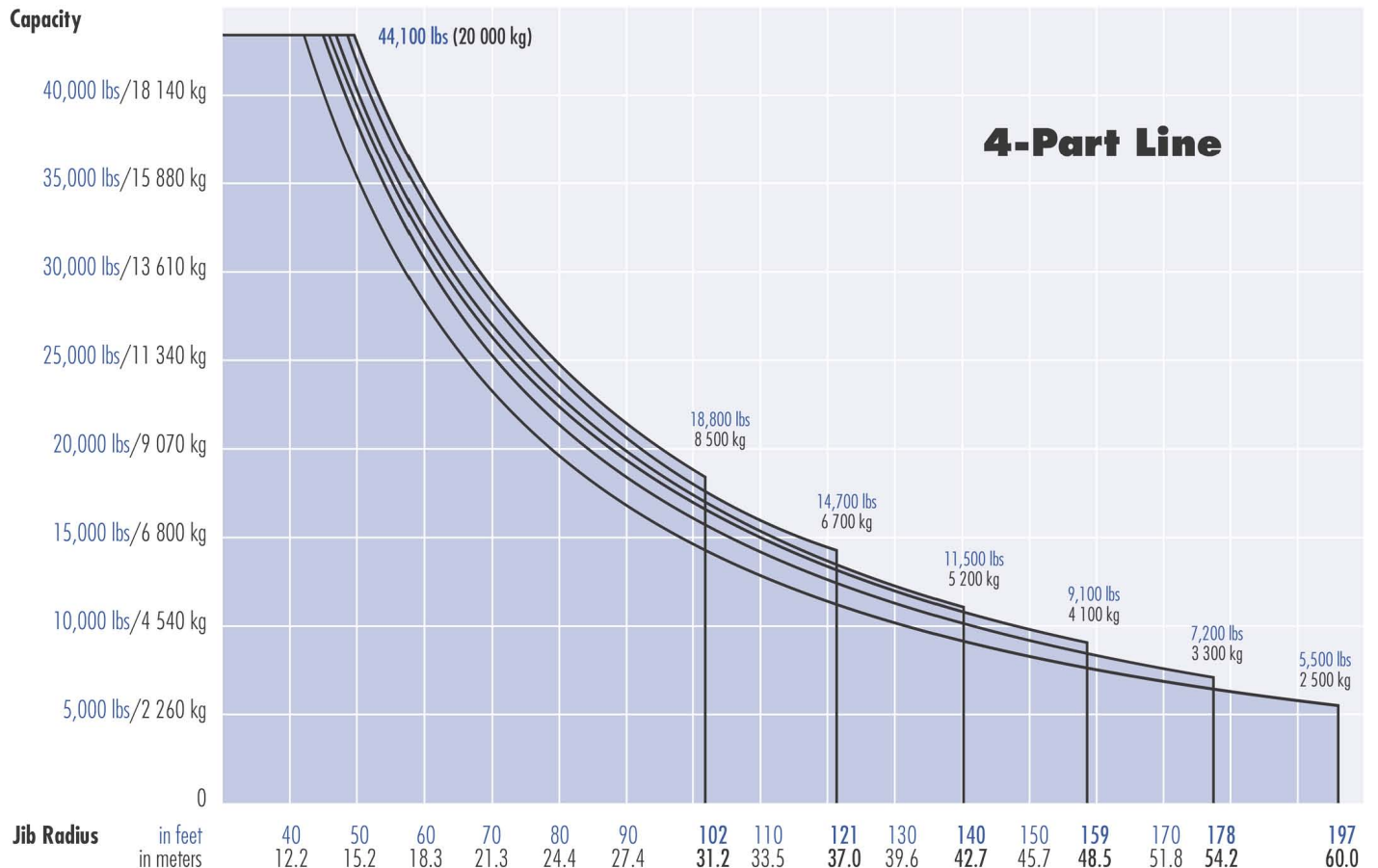

SPECIFICATIONS

Pecco Tower Crane Model SK 225

Hoist Speed and Capacity

Hoist Unit	2-Part Line				
105 hp (78 kW) AC hoist unit 4-speed gearbox Remote-controlled gear shifting Eddy current brake	Gear	Capacity	Hoist Speed	Capacity	Hoist Speed
	1	up to 22,050 lbs	@ 110 fpm	up to 10 000 kg	@ 34 m/min
	2	up to 14,800 lbs	@ 178 fpm	up to 6 700 kg	@ 54 m/min
	3	up to 9,260 lbs	@ 282 fpm	up to 4 200 kg	@ 86 m/min
	4	up to 5,500 lbs	@ 440 fpm	up to 2 500 kg	@ 134 m/min
	4-Part Line				
	1	up to 44,100 lbs	@ 55 fpm	up to 20 000 kg	@ 17 m/min
	2	up to 29,600 lbs	@ 89 fpm	up to 13 400 kg	@ 27 m/min
3	up to 18,520 lbs	@ 141 fpm	up to 8 400 kg	@ 43 m/min	
4	up to 11,000 lbs	@ 220 fpm	up to 5 000 kg	@ 67 m/min	

2P180
4P90

NOTE! Capacities and line speeds indicated will vary depending on the amount of hoist rope installed. This crane model may be equipped with a hoist unit other than that specified in the data above. To verify, check the serial number of the crane and refer to the Pecco SK 225 Operation Manual for additional information.

Motor Information

Drive Unit	Horsepower	Kilowatts	Speed	
Trolley (2-part line)	12 hp	9 kW	0 - 320 fpm	0 - 96 m/min
Trolley (4-part line)	12 hp	9 kW	0 - 160 fpm	0 - 48 m/min
Swing	2 x 12 hp	2 x 9 kW	1.0 rpm	











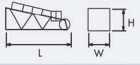
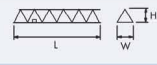
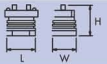
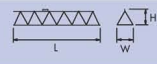

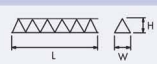

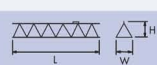

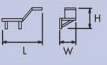

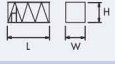

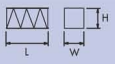

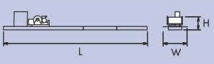
Power Requirements

480 V — 3-phase — 60 Hz — 250 Amperes

Specifications subject to change without notice.

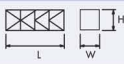
Component List

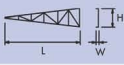

Description	Dimensions L x W x H	Weight	Description	Weight	
Tower Top	 28'-11" x 7'-2" x 8'-3" 8.8m x 2.18m x 2.5m	6,000 lbs 2 720 kg	Jib Section ①	 38'-9" x 6'-1" x 6'-5" 11.8m x 1.85m x 1.95m	8,000 lbs 3 630 kg
Turntable (Complete) Upper & Lower Part	 9'-4" x 10'-0" x 10'-9" 2.85m x 3.05m x 3.28m	21,000 lbs 9 525 kg	Jib Section ②	 38'-9" x 6'-1" x 6'-5" 11.8m x 1.85m x 1.95m	6,500 lbs 2 950 kg
Turntable Upper Part ¹	 9'-4" x 6'-9" x 7'-1" 2.85m x 2.05m x 2.16m	10,900 lbs 4 945 kg	Jib Section ③	 38'-4" x 6'-1" x 5'-9" 11.68m x 1.85m x 1.75m	4,500 lbs 2 040 kg
Turntable Lower Part ²	 8'-8" x 10'-0" x 3'-8" 2.64m x 3.05m x 1.12m	10,100 lbs 4 580 kg	Jib Section ④	 38'-5" x 6'-1" x 5'-9" 11.7m x 1.85m x 1.75m	3,800 lbs 1 725 kg
Operator's Cab	 5'-7" x 3'-11" x 6'-11" 1.7m x 1.2m x 2.1m	900 lbs 410 kg	Jib Section ⑤	 19'-3" x 6'-1" x 5'-9" 5.87m x 1.85m x 1.75m	1,440 lbs 655 kg
Cab Access Platform	 12'-8" x 5'-7" x 2'-9" 3.85m x 1.7m x 0.85m	1,000 lbs 455 kg	Jib Section ⑥	 19'-9" x 6'-1" x 5'-9" 6.02m x 1.85m x 1.75m	1,040 lbs 470 kg
Tower Section S35	 19'-5" x 7'-10" x 8'-0" 5.92m x 2.4m x 2.44m	8,900 lbs 4 040 kg	Jib Section ⑦	 13'-4" x 6'-1" x 6'-5" 4.06m x 1.85m x 1.95m	1,400 lbs 635 kg
Transition Section S60 to S35	 19'-5" x 7'-11" x 7'-11" 5.92m x 2.41m x 2.41m	9,930 lbs 4 500 kg	Jib Assembly Part 1 ⁶ for Jibs 125-ft to 200-ft	①② 75'-9" x 6'-1" x 6'-5" 23.1m x 1.85m x 1.95m	20,800 lbs 9 435 kg
Tower Section S60	 19'-5" x 7'-11" x 7'-11" 5.92m x 2.41m x 2.41m	9,930 lbs 4 500 kg	Jib Assembly Part 2 ⁷ 200-ft (61.0m)	③④⑤⑥⑦ 202'-3" x 6'-1" x 6'-5" 61.7m x 1.85m x 1.95m	12,880 lbs 5 840 kg
Counterjib A ³ (Complete)	 68'-6" x 10'-6" x 7'-10" 20.88m x 3.2m x 2.4m	23,000 lbs 10 430 kg	Jib Assembly Part 2 ⁷ 181-ft (55.2m)	③④⑤⑦ 183'-5" x 6'-1" x 6'-5" 55.9m x 1.85m x 1.95m	11,840 lbs 5 370 kg
Counterjib B ³ (Complete)	 51'-7" x 10'-6" x 7'-10" 15.73m x 3.2m x 2.4m	19,900 lbs 9 025 kg	Jib Assembly Part 2 ⁷ 163-ft (49.7m)	③④⑦ 164'-4" x 6'-1" x 6'-5" 50.1m x 1.85m x 1.95m	10,400 lbs 4 715 kg
Counterjib Section #1 (Inner)	 14'-9" x 6'-5" x 1'-10" 4.5m x 1.95m x 0.55m	2,900 lbs 1 315 kg	Jib Assembly Part 2 ⁷ 144-ft (43.9m)	③⑤⑦ 145'-4" x 6'-1" x 6'-5" 44.3m x 1.85m x 1.95m	7,440 lbs 3 375 kg
Counterjib Section #2 (Intermediate)	 16'-11" x 6'-5" x 1'-10" 5.15m x 1.95m x 0.55m	3,100 lbs 1 405 kg	Jib Assembly Part 2 ⁷ 125-ft (38.1m)	③⑦ 126'-8" x 6'-1" x 6'-5" 38.6m x 1.85m x 1.95m	6,000 lbs 2 720 kg
Counterjib Section #3 ⁴ (Outer)	 37'-9" x 10'-6" x 7'-10" 11.5m x 3.2m x 2.4m	17,000 lbs 7 710 kg	Jib Assembly (Complete) ⁸ 106-ft (32.3m)	①②⑤⑦ 107'-7" x 6'-1" x 6'-5" 32.8m x 1.85m x 1.95m	21,440 lbs 9 725 kg
Hoist Unit ⁵ (105 hp/78 kW)	 9'-2" x 8'-11" x 4'-7" 2.79m x 2.72m x 1.4m	6,300 lbs 2 855 kg	Top Climbing Unit with Hydraulics (S35)	 29'-3" x 11'-6" x 11'-6" 8.9m x 3.5m x 3.5m	24,750 lbs 11 230 kg
Counterweight Block A	 14'-8" x 7.5" x 5'-1" 4.47m x 0.19m x 1.55m	6,800 lbs 3 085 kg	Jib A-frame	 21'-7" x 5.5" x 4'-8" 6.57m x 0.14m x 1.43m	800 lbs 360 kg
Counterweight Block B	 9'-5" x 5.5" x 5'-1" 2.87m x 0.14m x 1.55m	3,200 lbs 1 450 kg	Hook Block	 2'-5" x 1'-1" x 5'-7" 0.74m x 0.33m x 1.69m	1,000 lbs 455 kg

NOTE! Weights and dimensions are approximate. Scale components before lifting.

¹ Turntable Upper Part includes swing motors and slewing ring. Does not include slewing ring support and support frame.

² Turntable Lower Part includes slewing ring support and support frame. Does not include Upper Part, swing motors and slewing ring.

³ Counterjibs A & B (Complete) include 105 hp (78 kW) hoist unit with frame, electrical panel and handrails. Does not include wire rope. Counterjib A (Counterjib Sections #1, #2 & #3) is required for jibs 163 ft (49.7m) and longer; Counterjib B (Counterjib Sections #1 & #3) is required for jibs of 144 ft (43.9m) and shorter.

⁴ Counterjib Section #3 includes 105 hp (78 kW) hoist unit with frame and electrical panel. Does not include wire rope.

⁵ Includes frame. Does not include wire rope.

⁶ Jib Assembly Part 1 includes jib sections, pendant cables, jib A-frame, trolley drive unit, trolley wire rope, 2-part trolley (outer) and hook block. If 4-part application is used, weight increases by 2,600 lbs (1 180 kg) for additional trolley (inner) and hook block.

⁷ Jib Assembly Part 2 includes jib sections and pendant cables.

⁸ Jib assembly (complete) includes jib sections, pendant cables, trolley drive unit, trolley wire rope, 2-part trolley (outer) and hook block. If 4-part application is used, weight increases by 2,600 lbs (1 180 kg) for additional trolley (inner) and hook block.